

# Proximity Keypads Reader

## Operation Manual

Model: 6630KE/6630KDE



**KEYKING** KEYKING GROUP LIMITED

# Index

Chapter 1: Summarize.....	2
1.1 Summarize .....	2
1.2 System Characteristics .....	3
Chapter 2: 6630KE System Instructions:.....	4
2.1 6630KE surface:.....	4
2.2 LED:.....	4
2.3 6630KE Wiring: .....	5
2.4 Mode setting:.....	5
2.3.1 Wiegand 26 Bits .....	6
2.3.2 Wiegand 34 Bits .....	6
2.5 Communication Interface:.....	6
Chapter 3: Keypads Output.....	7
3.1 Keypad Message .....	7
Chapter 4: Installation.....	8
4.1 Install on the wall (Based on Internal Back Box) .....	8
4.2 Install on the wall (Based on Surface Back Box).....	9
4.3 Install on the wall (Surface, Without Back Box).....	10
4.4 Notes .....	12
Chapter 5: Configuration.....	13
5.1 Application: 6630KX Reader Display Setting .....	13
5.2 RS485 to RS232 converter.....	14
5.3 Configuration Steps.....	15
5.4 Change clock.....	16
5.4.1 Change clock by Keypads .....	16
5.4.2 Change clock by Configuration software.....	16
5.4.3 Synchronize Clock by RS485 bus from Panel .....	16

# Chapter 1: Summarize

## 1.1 Summarize

Reader Model Define:

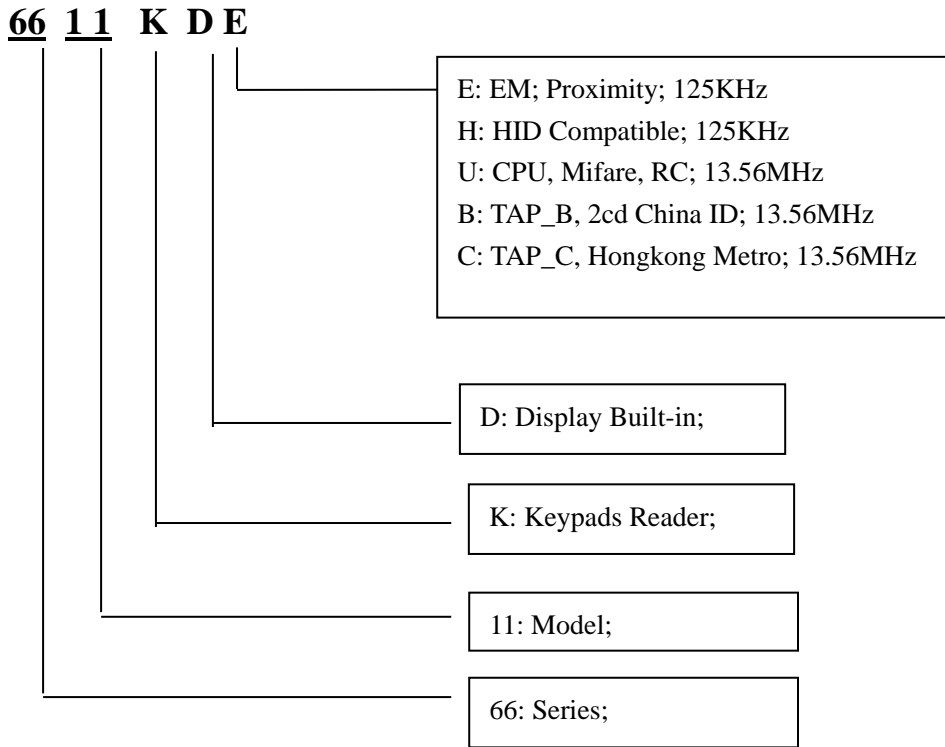

### Support Card Type:

- E:** EM; For example: EM4100, TK4100 series.
- M:** Mifare-; For example: Philips S50, S70 series smart cards.
- RC:** Mifare Sector; For example: Philips S50, S70 series smart cards.
- H:** HID Compatible; For example: 1326, 1386 and tags.
- T:** Temic, like E5557;
- S:** 15693; For example: Ti series cards.
- B:** TAP\_B, For example: Chinese 2cd Identifitation;
- C:** TAP\_C, Hongkong Metro;

## 1.2 System Characteristics

Technical Parameters:

- Power: 12 VDC  $\pm$  10%, 200mA
- Dimensions: 90mm (H) x 90mm (W) x 22mm (D)
- Weight: 200 grams
- Operating Frequency:

**125KHZ:**

- E: EM;
- H: HID;
- T: Temic;

**13.56MHZ:**

- B: TAP\_B;
- C: TAP\_C;
- M: Mifare;
- RC: Mifare Sector;
- S: 15693;

- Read Range: 5 to 15 cm
- LED indicators: Dual LEDs, Blue&Green, or Red&Green.
- Back Ground Light: Blue.
- Display Screen: **OLED**, Dual Color: Yellow, Blue



# Chapter 2: 6630KE System Instructions:

## 2.1 6630KE surface:

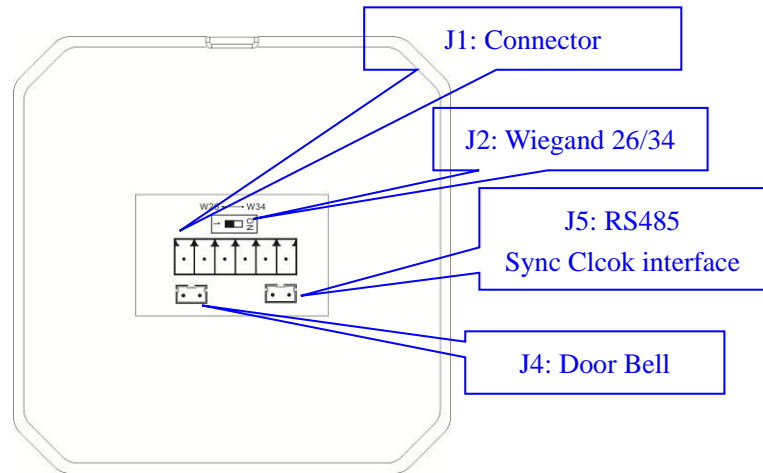
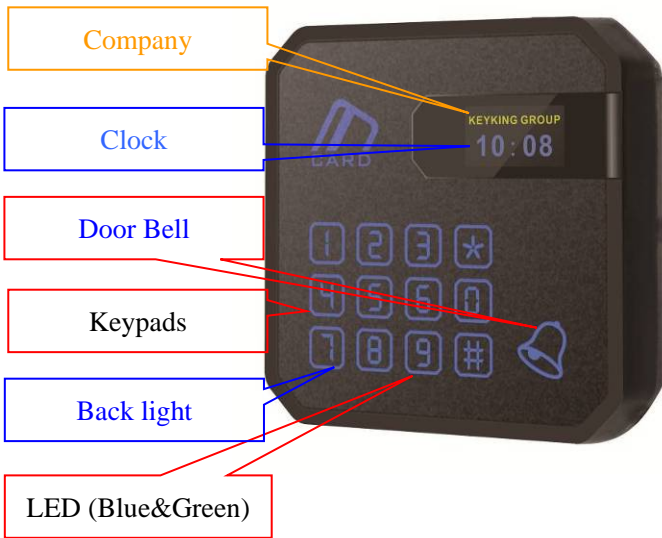

LED:

## 2.2 LED:

- Blue LED for power indication.
- Green LED for card reading indication.

### Details of Keypads:

No.	Mark	Definition	Output(BIN)	No.	Mark	Definition	Output(BIN)
1	1	Digital 1	0001	7	7	Digital 7	0111
2	2	Digital 2	0010	8	8	Digital 8	1000
3	3	Digital 3	0011	9	9	Digital 9	1001
4	4	Digital 4	0100	10	0	Digital 0	0000
5	5	Digital 5	0101	1	*	Cancel / Start	1010
6	6	Digital 6	0110	12	#	Enter / Confirm	1100

## 2.3 6630KE Wiring:

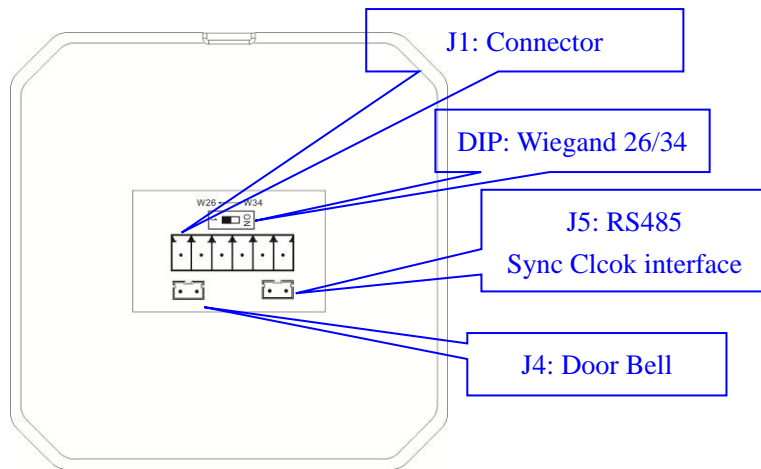

### J2: Wiring Connector (Definition of wiring):

No.	Mark	Definition	Note
1	+12V	Power Supply	
2	D1	Data 1	
3	D0	Data 0	
4	LED	LED control, when it was shorted with GND, then LED will change the color.	
5	GND	GND, Ground Wire	
6	BUZ	Buzzer control, when it was shorted with GND, then Buzzer will beep.	

### J3: Door Bell:

- ✓ Normally the 2 wires are open.
- ✓ When you press Door Bell Key, the 2 wires will be shorted.

## 2.4 Mode setting:

### DIP Switch: Wiegand Selector:

- OFF: the reader will output Wiegand 26 bits format.
- ON: the reader will output Wiegand 34 bits format.

### **2.3.1 Wiegand 26 Bits**

Please keep DIP Switch on the OFF, then the reader will output Wiegand 26 bits format.

### **2.3.2 Wiegand 34 Bits**

Please keep DIP Switch on the ON, then the reader will output Wiegand 34 bits format.

## **2.5 Communication Interface:**

### **J5: RS485 Inteface:**

- **Configuration interface with PC.**
- **It can work with IC-232 or RS485HUB converter.**

J5:

- RS485+
- RS485-

# Chapter 3: Keypads Output

## 3.1 Keypad Message

The reader will process the keypad entries in the reader and then transmits the data to the host system via the Wiegand data lines. The reader outputs each key as an ASCII encoded hexadecimal digit. The decoding of the message sent through the Wiegand interface is the only processing required of the host system. The user interface has been implemented in the most generic fashion to give the integrator the most flexibility.

The keypad message follows a basic format.

0 = 0000	4 = 0100	8 = 1000
1 = 0001	5 = 0101	9 = 1001
2 = 0010	6 = 0110	* = 1010
3 = 0011	7 = 0111	# = 1011

**The reader will transmit every key value individually, after it was pushed.**

For example:

- If you push "1", then the reader will transmit "0001" to the host (Panel or controller).
- If you push "1" and "2", then the reader will transmit "0001" to the host (Panel or controller), then transmit "0010" to the host.



# Chapter 4: Installation

## Installation Procedure:

### 4.1 Install on the wall (Based on Internal Back Box)

1. **Install a Reader Back Box inside wall:** Determine an appropriate **mounting position** for the reader. Install a single or double standard electrical box (86\*86mm) inside wall. If mounting to a metal surface, drill two 7/64 (.109) inch holes and use the enclosed self tapping screws for mounting.



a). Reader Back Box (Standard Electronic Box, single)      b). Reader Back Box (Double)

2. **Route:** Route the interface cable from the reader to the Host.
3. **Wiring:** Install all wires to the green connector according below image.

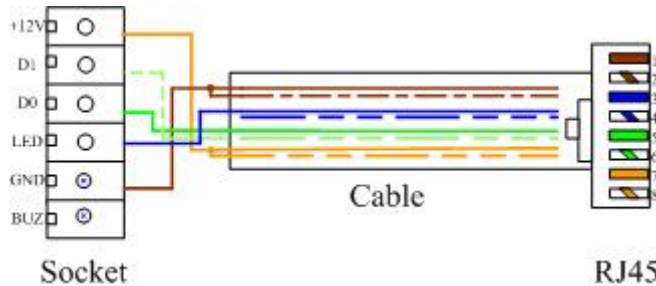

4. **Plug the Green Connector:** Plug the green connector to the reader socket.
5. **Set the JUMPER (Output mode):** select W26 or W34 bits output of reader.
6. **Mount the reader body:** Mount the reader body to the Electronic Box (Reader Back Box) using the two screws. Two #6-32 x 1 inch screws are provided for mounting to a gang box or metal surface.
7. **Put the top cover** and face plate.

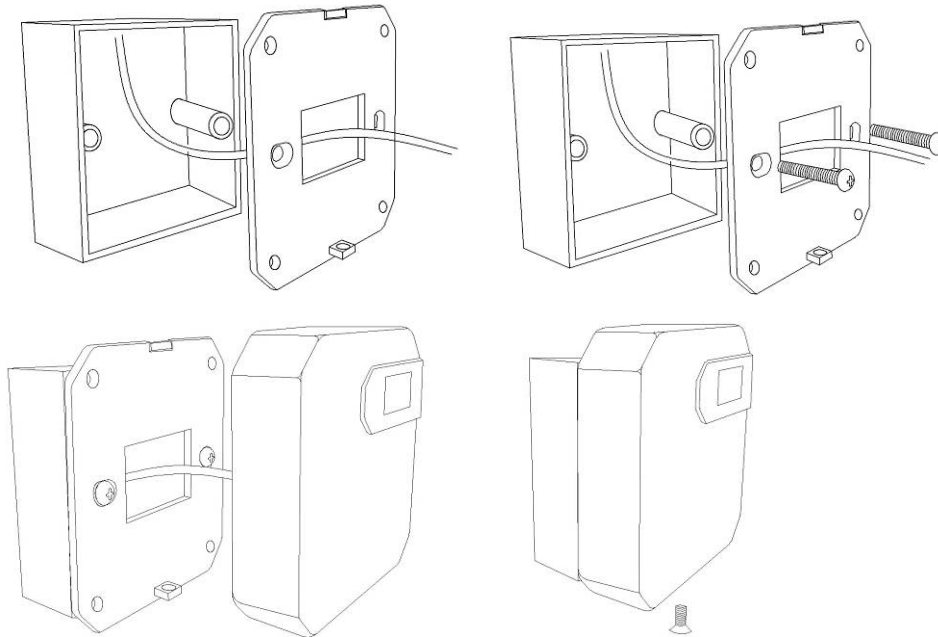

## 4.2 Install on the wall (Based on Surface Back Box)

1. **Install a Reader Back Box on wall:** Determine an appropriate **mounting position** for the reader. Install a single or double standard electrical box (86\*86mm) on the wall using 4 screws.



a). Reader Back Box (Surface, Standard Electronic Box, single)

2. **Route:** Route the interface cable from the reader to the Host.
3. **Wiring:** Install all wires to the green connector according below image.

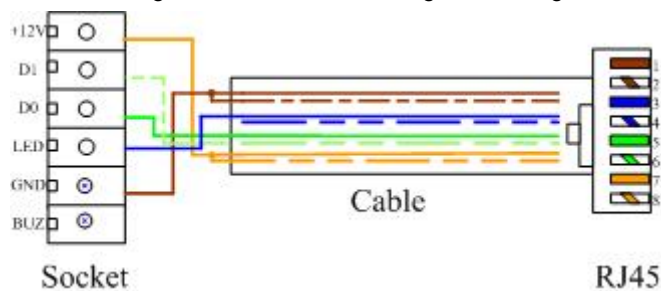

4. **Plug the Green Connector:** Plug the green connector to the reader socket.

5. **Set the JUMPER (Output mode):** select W26 or W34 bits output of reader.
6. **Mount the reader body:** Mount the reader body to the Electronic Box (Reader Back Box) using the two screws which is  $\phi 4$ , 30mm length.
7. **Put the top cover and face plate.**

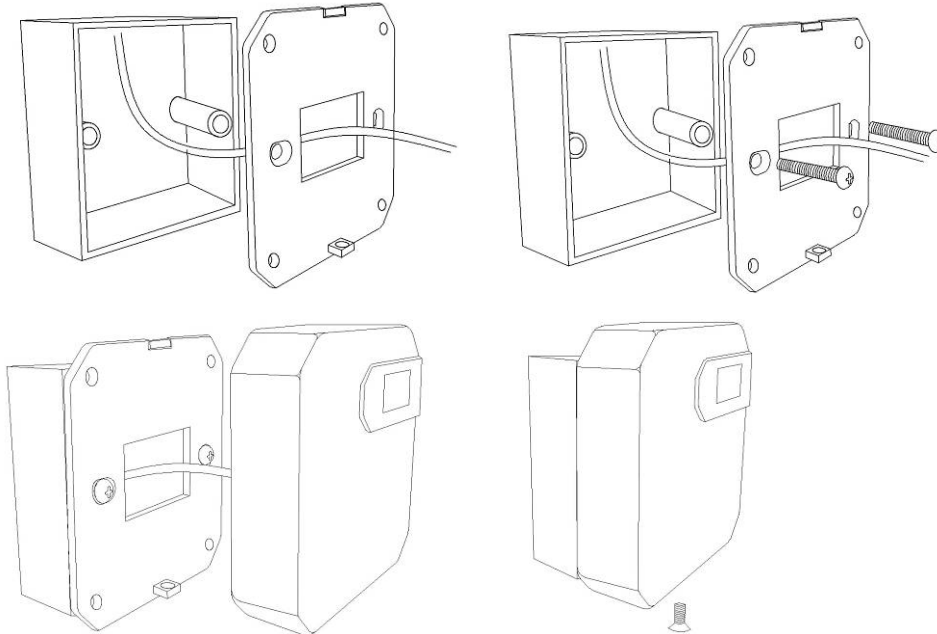

### 4.3 Install on the wall (Surface, Without Back Box)

1. **Drill a  $\phi 30$  hole on the wall:** Drill a  $\phi 30$  hole using a professional drill.

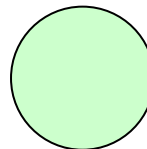

a).  $\phi 30$  drill, professional tool

b). A hole on the wall,  $\phi 30$

Note: This drill can drill the metal wall and wood wall, can not drill stone or cement wall.

2. **Route:** Route the interface cable from the reader to the Host.
3. **Wiring:** Install all wires to the green connector according below image.

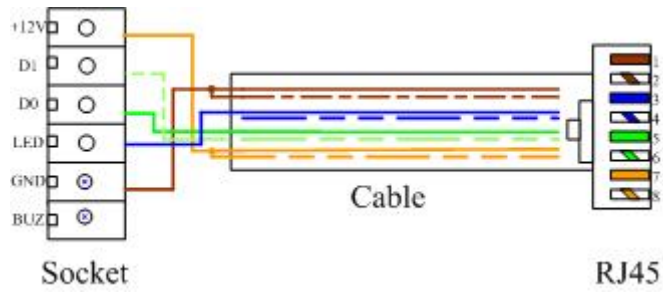

4. **Plug the Green Connector:** Plug the green connector to the reader socket.
5. **Set the JUMPER (Output mode):** select W26 or W34 bits output of reader.
6. **Mount the reader body:** Mount the reader body to the Electronic Box (Reader Back Box) using the two screws which is  $\phi 4$ , 30mm length.
7. **Put the top cover** and face plate.

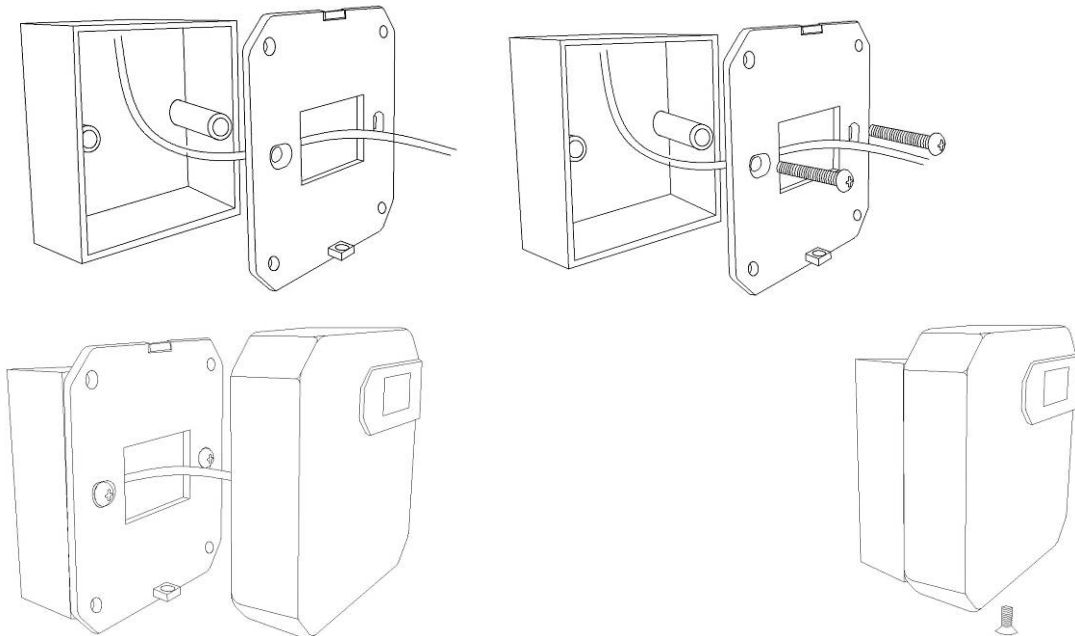

## 4.4 Notes

### Cable Notes:

- 1) **Cable type:** Category 5 with shield.
- 2) **Same Ground:** the reader and Host must have the same ground. If you use different power supply for reader and controller, please connect the GND of reader to GND of controller.
- 3) **Max Cable Length:** The MAX LENGTH is up to 60 meters from controller to reader.
- 4) **Shield:** Shield wire should be connected to GND of controller.

### Other Notes:

- 1) **Metal disturbing:** the reader can not be installed on the metal wall, otherwise it will affect the read range. Sometimes the reader can not read cards. So you should avoid the metal when you install the reader.

# Chapter 5: Configuration

## 5.1 Application: 6630KX Reader Display Setting

**6630KX Reader Display Setting:** It is an application to configure 6630 series reader & TC419.

- Before you run this application, please make sure you have a converter (IC-232) for 6630 Series reader.
- Before you run this application, please make sure there is a free serial port in your PC.

Run 6630KX Card Reader Display Setting application, you will see below image #5-1.

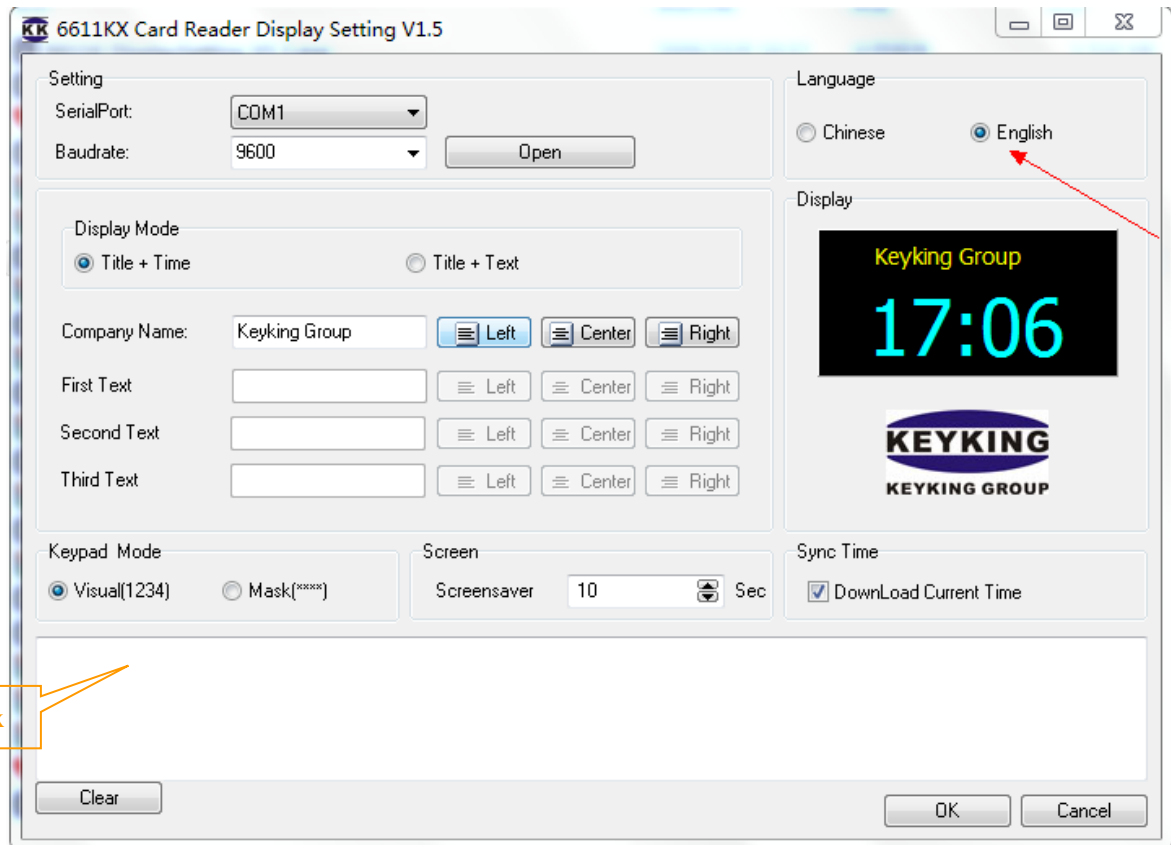

Image #5-1

- **Serial Port:** You should select a serial port to communicate with 6630 series reader, like COM1. Click **Open** or **Close** button to open/close the serial port.
- **Language:** You can choose Chinese or English, then the message of the reader will follow the option you ticked.
- **Display Mode:** You can "Title + Clock" or "Title + Text"  
**Title +Clock:** You can type your company name, and select the position (**Left, Center, Right**)

which should be on the display.

**Title +Text:** 3 lines Text. You can type "1st Line Text", "2cd Line Text", and "3rd line Text" (**Left, Center, Right**) which should be on the display.

■ **Keypad Mode:**

**Visual (1234):** The display will show what you press. For example: if you press "1234", then you will see "1234" on the display.

**Mask (\*\*\*\*):** The display will show "\*" no matter what you press. For example: if you press "1", then you will see "\*\*\*\*" on the display.

■ **ScreenSaver:** You should choose the screen saver time, and once you select it, the display message will disappear after this time. **0 means never screen saver (0=unlimited).**

■ **Download Current Time:** You can get the clock from PC, and download to the reader.

**Selected:** You will get the current time from PC, and download to the reader. Then the reader clock will be the same with your PC.

**UnSelected:** You will not download the current time of PC to the reader. Then the reader clock will display the old clock only.

■ **Clear:** It will clear all messages of message box after you click **Clear** button.

## 5.2 RS485 to RS232 converter

You can use any RS485 to RS232 converter between 6630K and PC application.

For example: IC-232 or RS485HUB. Of course you can use another brand converter also, but please make sure it support **9600Bps** Baud Rate.



Image #5-2

Please make sure the Baud Rate is **9600Bps**.

- If you use IC-232 conver, please put DIP1, DIP3,DIP4 are ON position and DIP2 is OFF.
- If you use RS485HUB, you need no care about the baud rate.

## 5.3 Configuration Steps

When you do configuration, need no give power supply to reader. The reader will get power from USB of PC.

Before you connect the cable, please make sure you already take out the power supply for 6630 series reader.

1. Connecting:

- Plug white connector of Downloader to J5 on the back of reader.
- Connect 485+ of J5 to 485+ of IC-232, 485- of J5 to 485- of IC-232.
- Regarding IC-232, please put DIP1, DIP2, DIP3, DIP4 are ON position, let it work under 38400Bps.
- Give IC-232 converter power supply.
- Plug the DB9 female connector of cable to Serial Port of PC.
- Plug the DB9 female connector of cable to IC-232.



Image #5-3 Diagram for IC-232

After connecting, the reader will work, and you will see the display information.

2. Configuring by 6630KX Reader Display Setting:

- Choose a Serial Port, and Open it.
- Type the Company Name (like: **Keyking Group**), and choose the position.
- Choose a kind of Keypad Mode, Visual or Mask.
- Choose "Download current time" or not.
- Click **OK** Button. You will see "Succeed to configure reader" message in the message box.
- Done. You will see the changes.



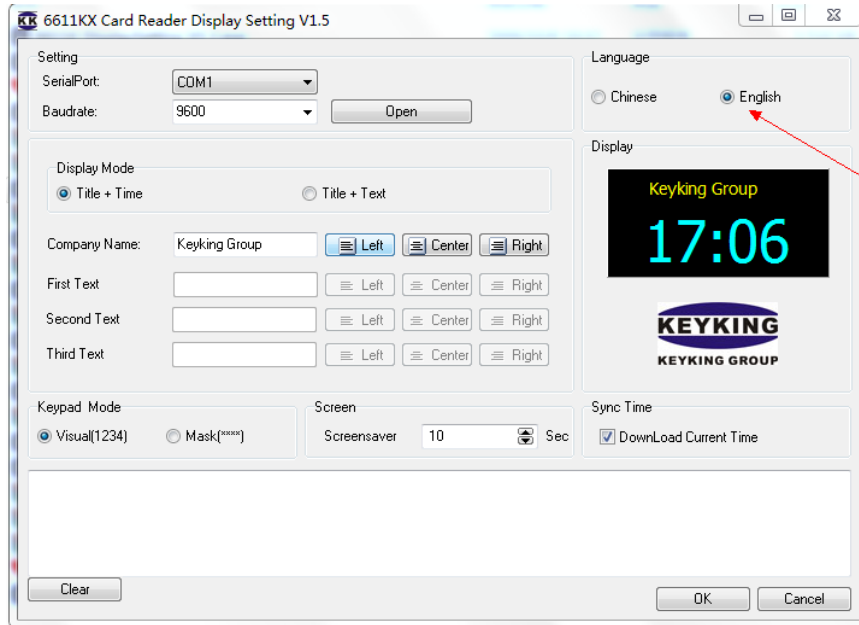

## 5.4 Change clock

### 5.4.1 Change clock by Keypads

Steps:

1. Power off 6630KE.
2. Power on 6630KE.
3. You will message “Update Clock/Time?”
4. Type “201509251601” according “YYYYMMDDHHMM”, and press “#” to confirm
5. Done

### 5.4.2 Change clock by Configuration software

Please follow 5.3.

You can change clock by keypads also.

### 5.4.3 Synchronize Clock by RS485 bus from Panel

6630KDM Diagram:

1. Wiegand Signal wires (+12V, GND, D0, D1, LED, Buzzer).
2. RS485 Sync clock wires: RVV2\*0.5 to Access control Panel.

